

# SAFARI 1D1W

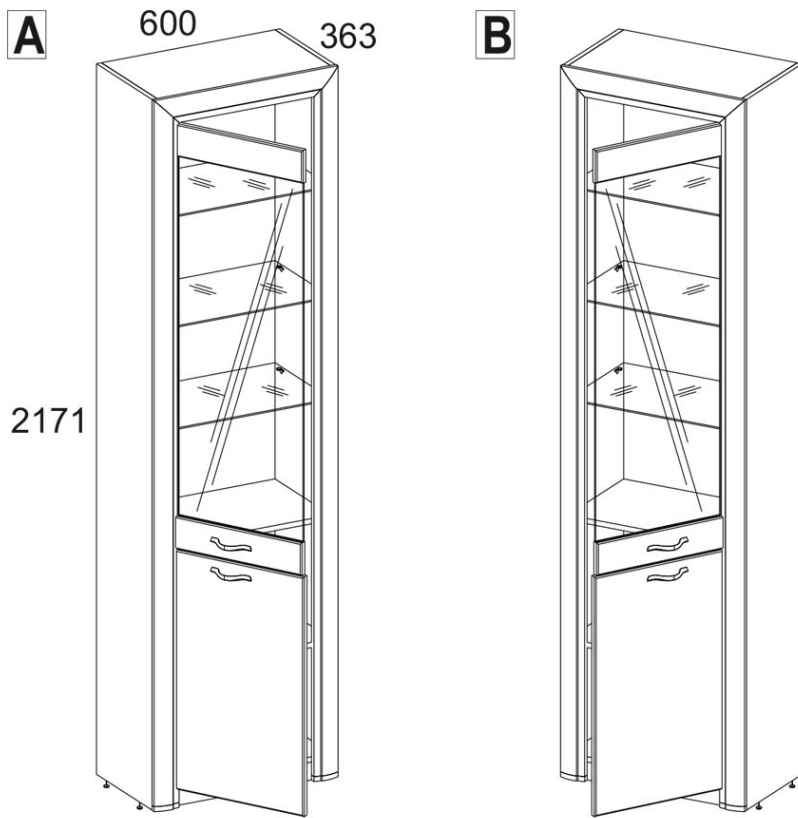

kód	L, mm	B, mm	H, mm		somag
1	566	335	16	1	1/4
2	566	335	16	2	1/4
3	564	335	16	1	1/4
4	564	325	6	3	1/4
6	2166	335	16	1	2/4
7	2166	335	16	1	2/4
8	2152	80	25	1	3/4
9	2152	80	25	1	3/4
10	600	80	25	1	3/4
11	1294	436	16	1	2/4
12	436	730	16	1	2/4
13	1374	592	2,5	1	4/4
14	730	592	2,5	1	4/4
25	566	55	16	1	3/4

A bűtor használatakor:

- tilos a bűtorokat fűtőberendezések közelében és nedves falak mellett elhelyezni, valamint olyan helyiségekben, ahol a relatív páratartalom meghaladja a 70%-ot;
- a bűtorelemek fűtési hőmérséklete nem haladhatja meg a + 40° C-ot;
- a bűtorok összeszerelése és használata során tilos a vízszintes paneleken és ablakokon állni;
- tilos a vegyi tisztítószer használata a bűtorok tisztításához;
- nem szabad víznek kitenni.

Illat.

Az új bűtorok azon anyagok szagát árasztathatják, amelyekből készültek. A szag az összeszerelés után akár három hétig is megmaradhat. Az illat intenzitásának csökkentése érdekében ajánlott:

- kárpitozott bűtorok esetén - kiporszívózni a terméket és kiszellőztetni a helyiséget.

Ismételje meg naponta 3-4 alkalommal.

- szekrénybűtorok esetén - törölje le enyhe tisztítószerrel megnedvesített ronggyal, majd törölje le tiszta, száraz ronggyal és szellőztesse ki a helyiséget, de először nyissa ki a termék összes ajtaját és fiókját.

Ismételje meg naponta 3-4 alkalommal. Fontos! Kérjük, őrizze meg az utasításokat, hiszen szüksége lehet rájuk a bűtorok ismételt összeszerelése vagy reklamáció esetén. Panasz benyújtásakor kérjük, használja a kézikönyvben található jelöléseket.

**FIGYELEM!** Egy bűtordarab leesése súlyos vagy halálos sérüléseket okozhat. **MINDIG** rögzítse ezt a bűtordarabot a falhoz a rögzítőelemekkel. A beágyazott csapot téglá- és betonfalakhoz használják. A falra szereléshez a fal anyagának megfelelő





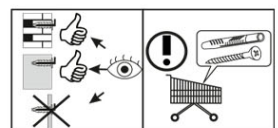
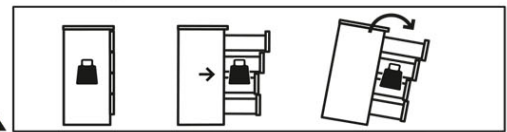

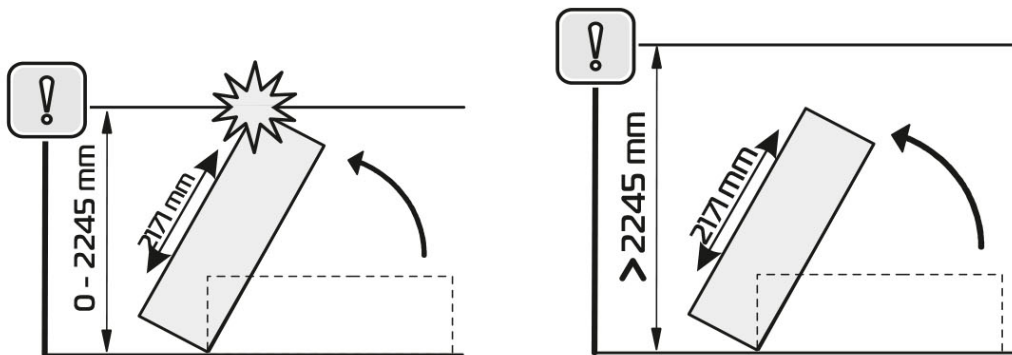
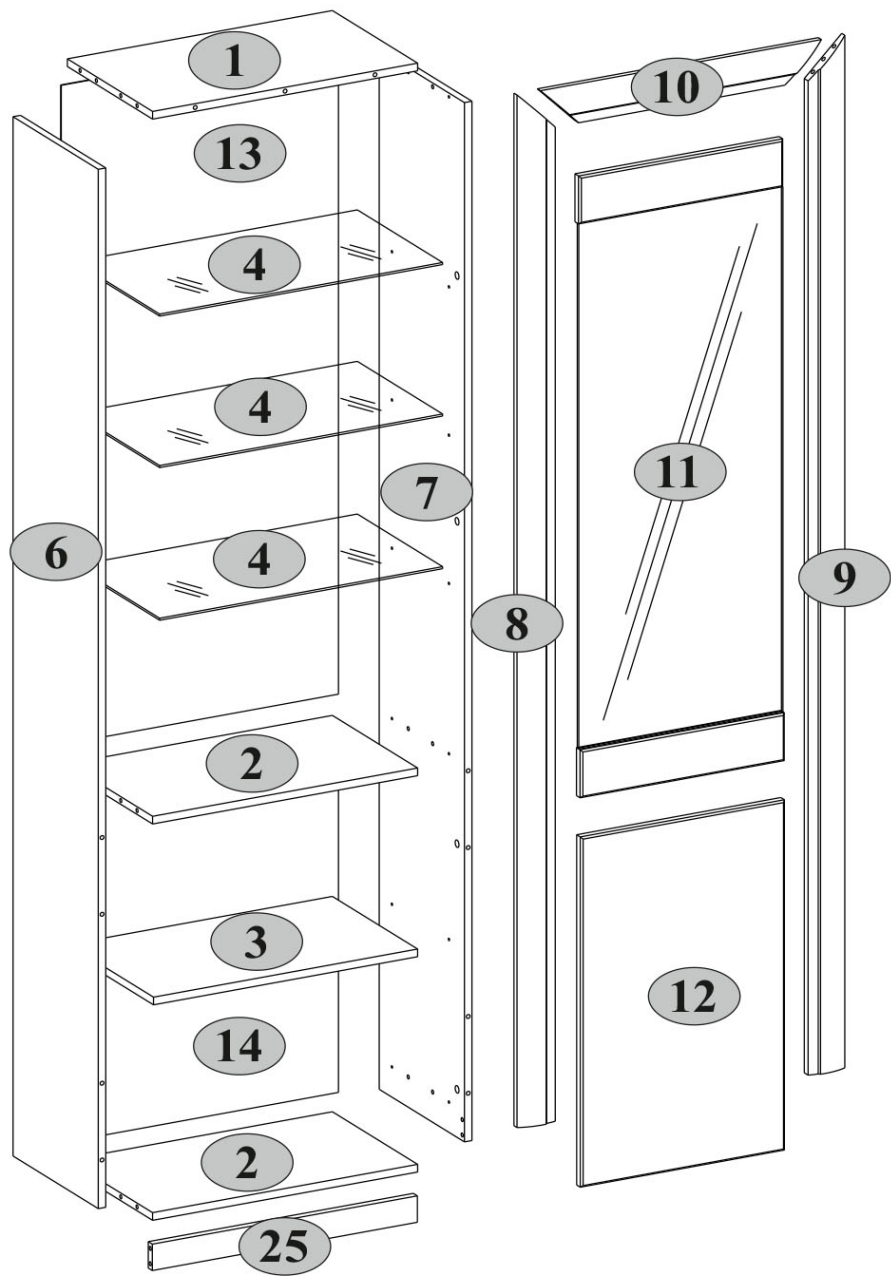

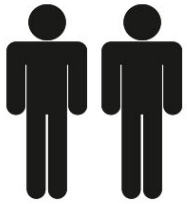



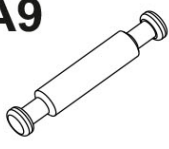

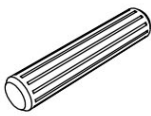
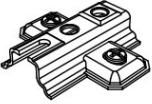
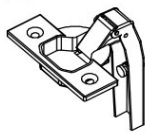

rögzítőelemeket használjon, ha nem biztos abban, hogy a fal anyagához milyen rögzítési mód megfelelő, forduljon szakemberhez vagy látogasson el egy szaküzletbe. A rögzítőelemekért végső soron a szerelő a felelős. A bűtor felborulása miatti súlyos testi sérülések és halálesetek kockázatának további csökkentése érdekében:

- A legnehezebb tárgyakat helyezze az alsó fiókba.
- Ne helyezzen nehéz tárgyakat rá.
- Soha ne engedje, hogy a gyerekek felmásszanak a fiókokra, ajtókra vagy polcokra.
- A bűtorokat rendeltetésszerűen használja

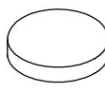



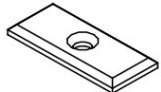

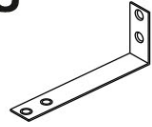
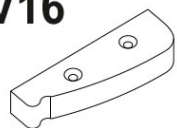

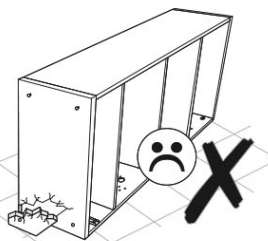
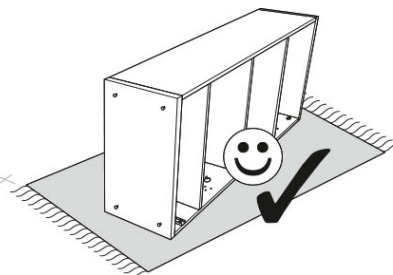
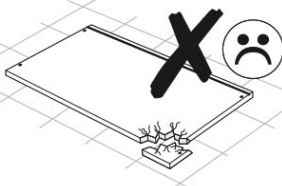
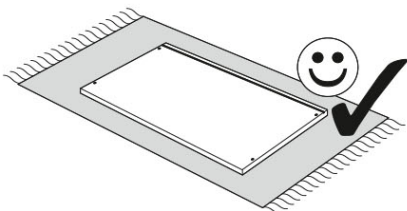
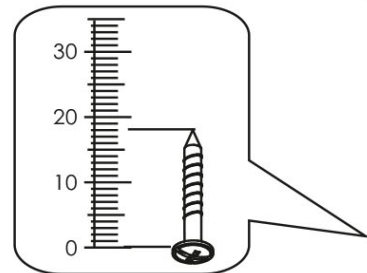
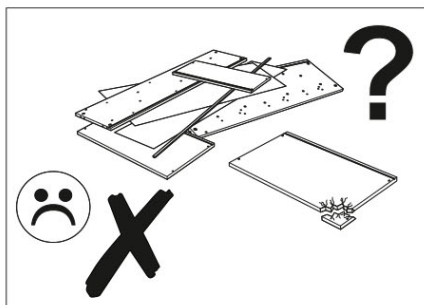
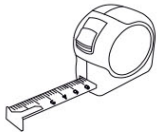
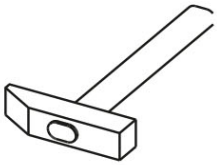
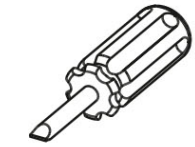
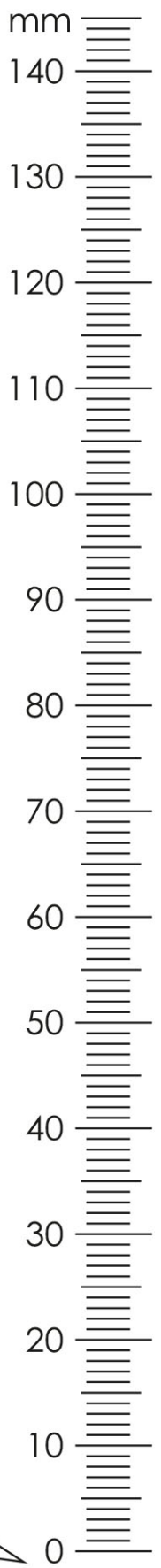

<b>A1.0</b>  5x28 22	<b>A2</b>  15x13 26	<b>A9</b>  L-47,4 2	<b>B5</b>  10x50 1
<b>C1</b>  8x35 29	<b>D1</b>  4	<b>E2</b>  4	<b>G</b>  1,5x26 36
<b>H63</b>  2	<b>M4</b>  M4x22 4	<b>N1</b>  4	<b>P1</b>  Ø5 4
<b>P4</b>  12	<b>Q</b>  1,5x7 2	<b>R3</b>  3x20 2	<b>R5</b>  3x30 4
<b>R23</b>  6,3x13 8	<b>R102</b>  3,5x16 10	<b>S3</b>  2	<b>S5</b>  Ø18 18
<b>U</b>  130x35x15 1		<b>V16</b>  80x25x15 2	



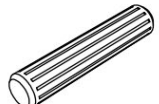

# 1

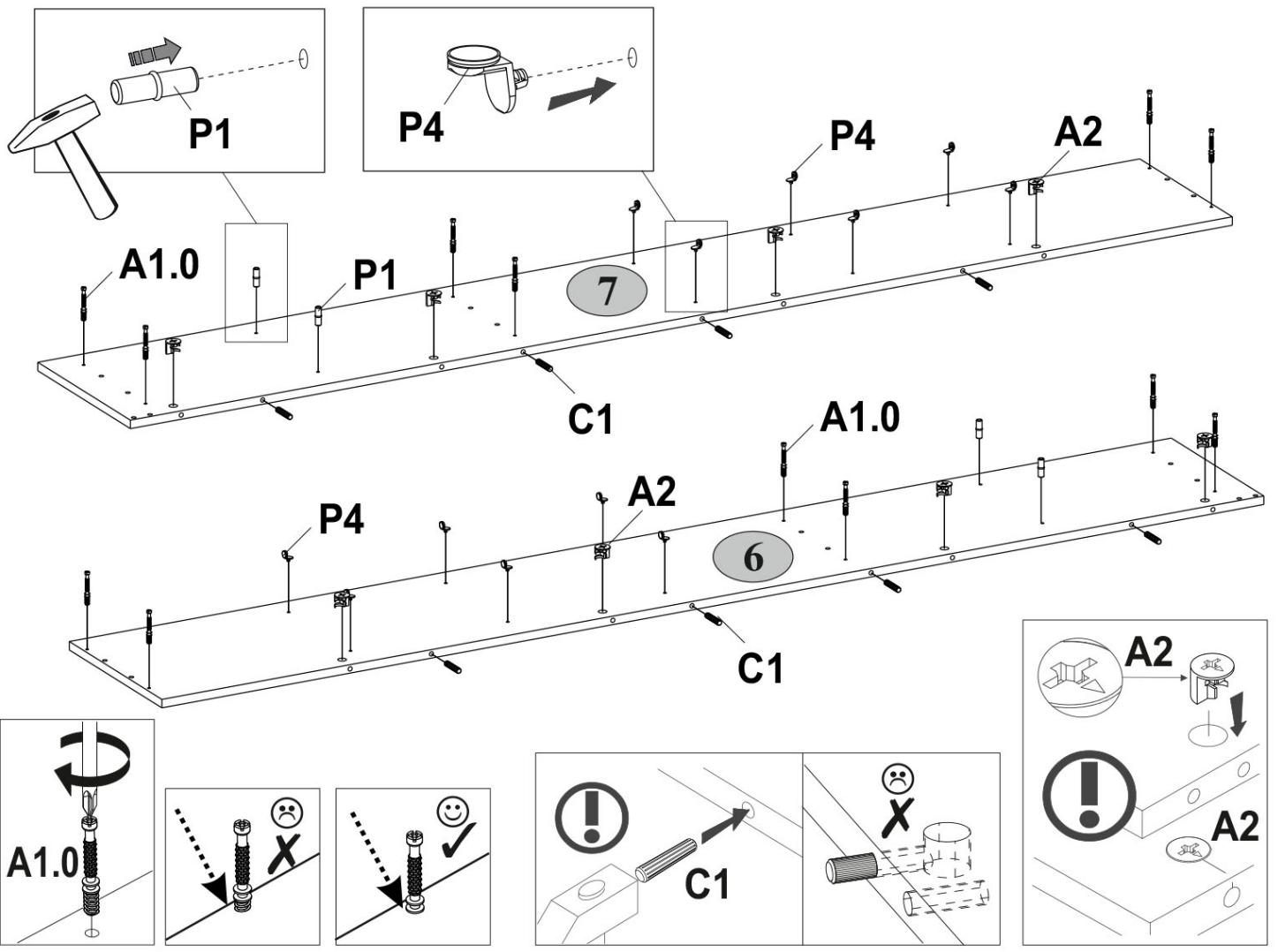
<b>A1.0</b>  5x28 12	<b>A2</b>  15x13 8	<b>C1</b>  8x35 8	<b>P1</b>  Ø5 4	<b>P4</b>  12
--	--	---	--	--

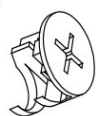

# 2

<b>A2</b>  15x13 6	<b>C1</b>  8x35 5
--	---

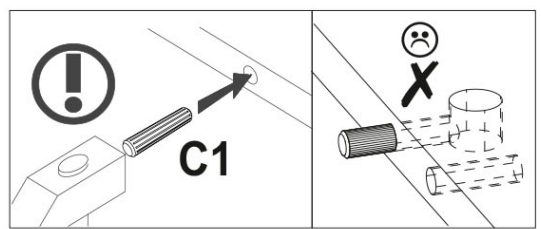
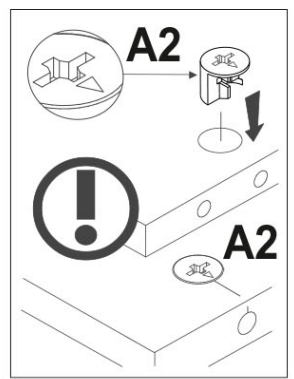
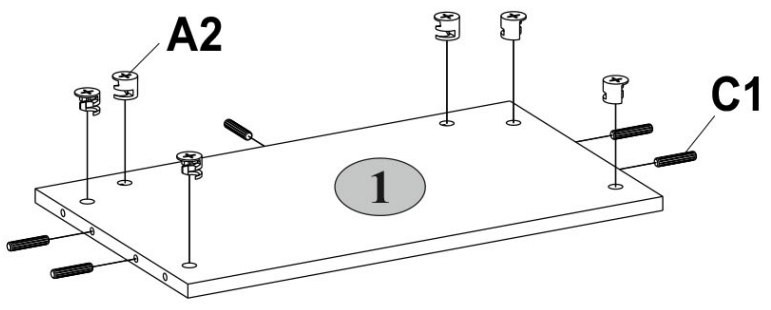

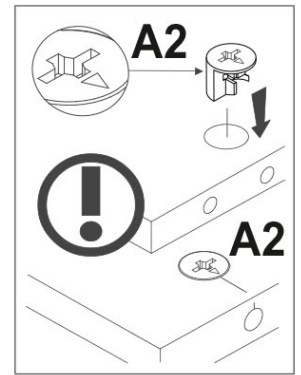
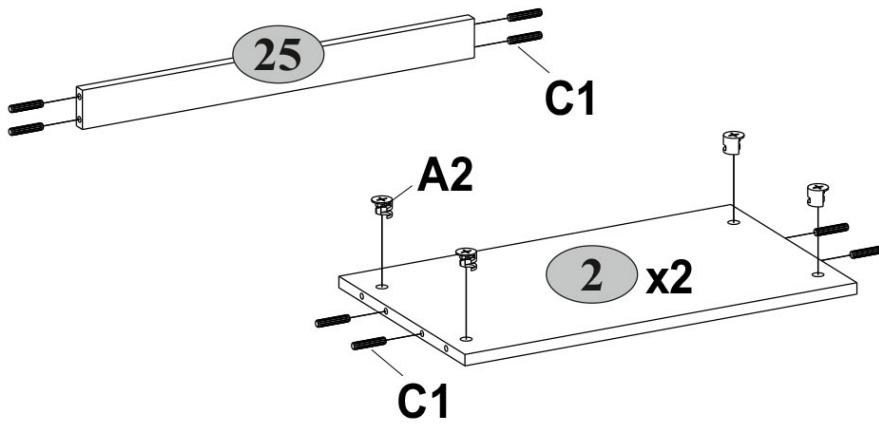
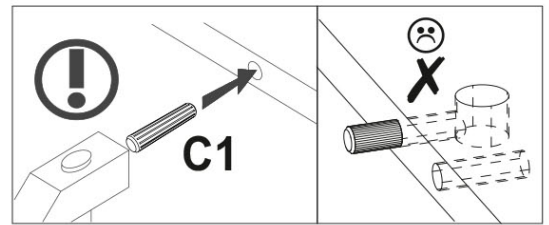
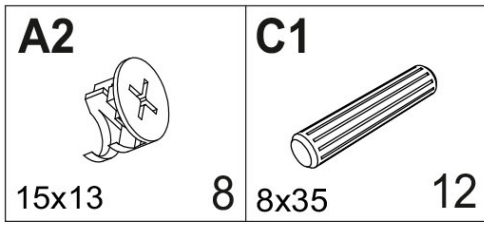

**3**

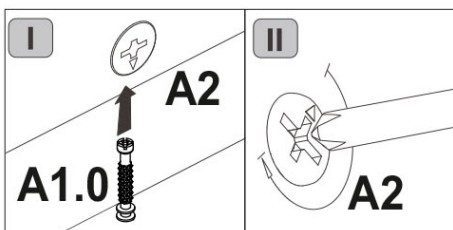
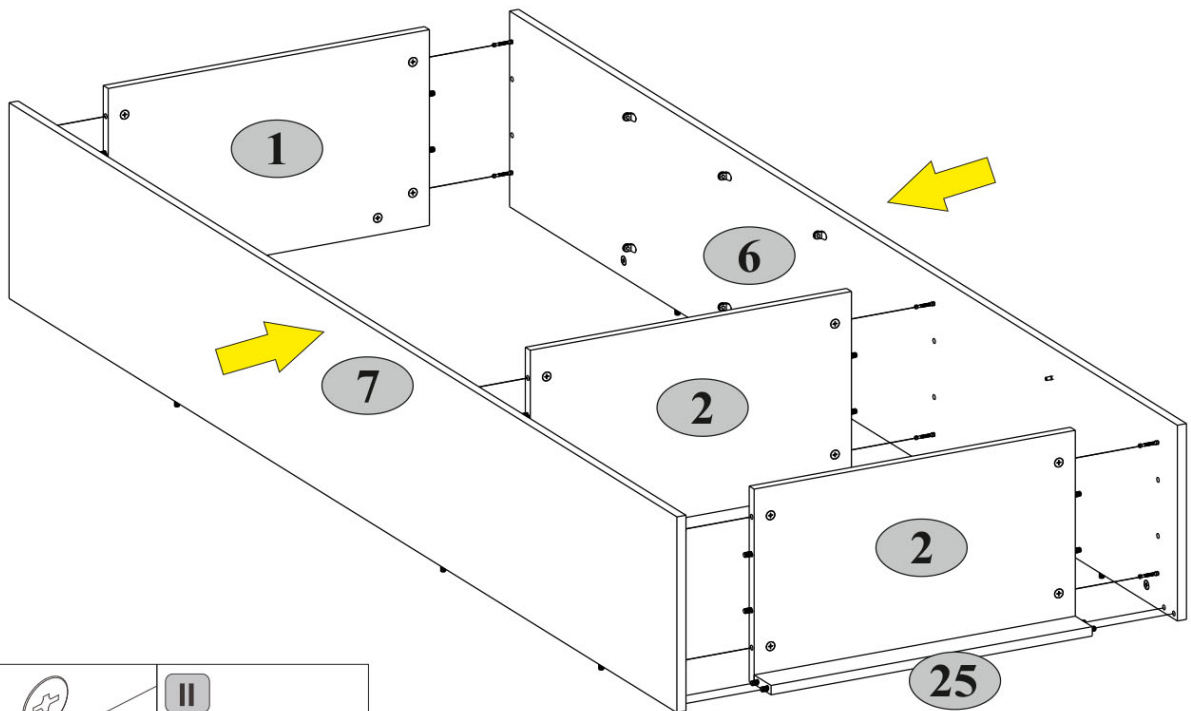

**4**





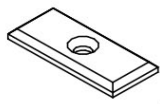

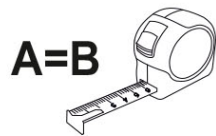
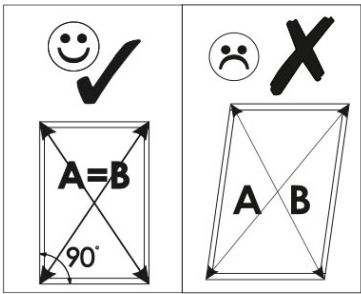
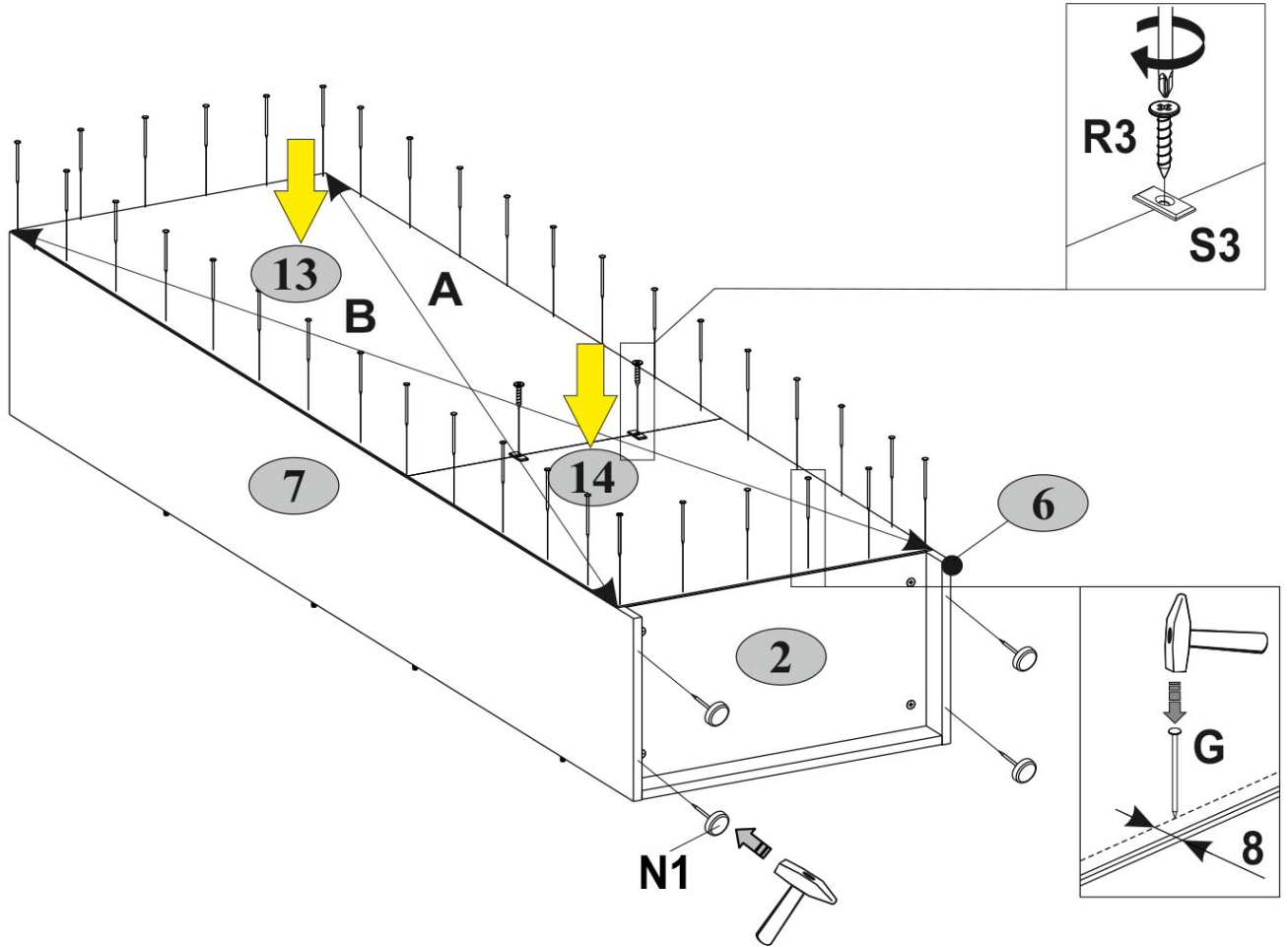
**5**

<b>G</b>  1,5x26 36	<b>N1</b>  4	<b>R3</b>  3x20 2	<b>S3</b>  2
---	---	---	--

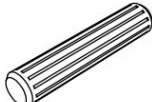

**6**

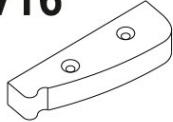
<b>A1.0</b>  5x28 10	<b>A2</b>  15x13 4	<b>A9</b>  L-47,4 2	<b>C1</b>  8x35 4	<b>R5</b>  3x30 4	<b>V16</b>  80x25x15 2
--	--	---	--	---	--

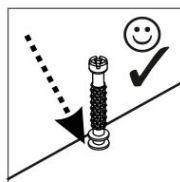
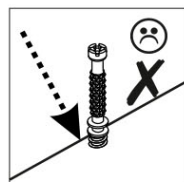
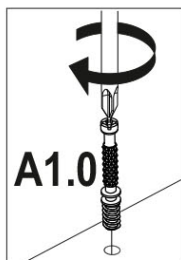
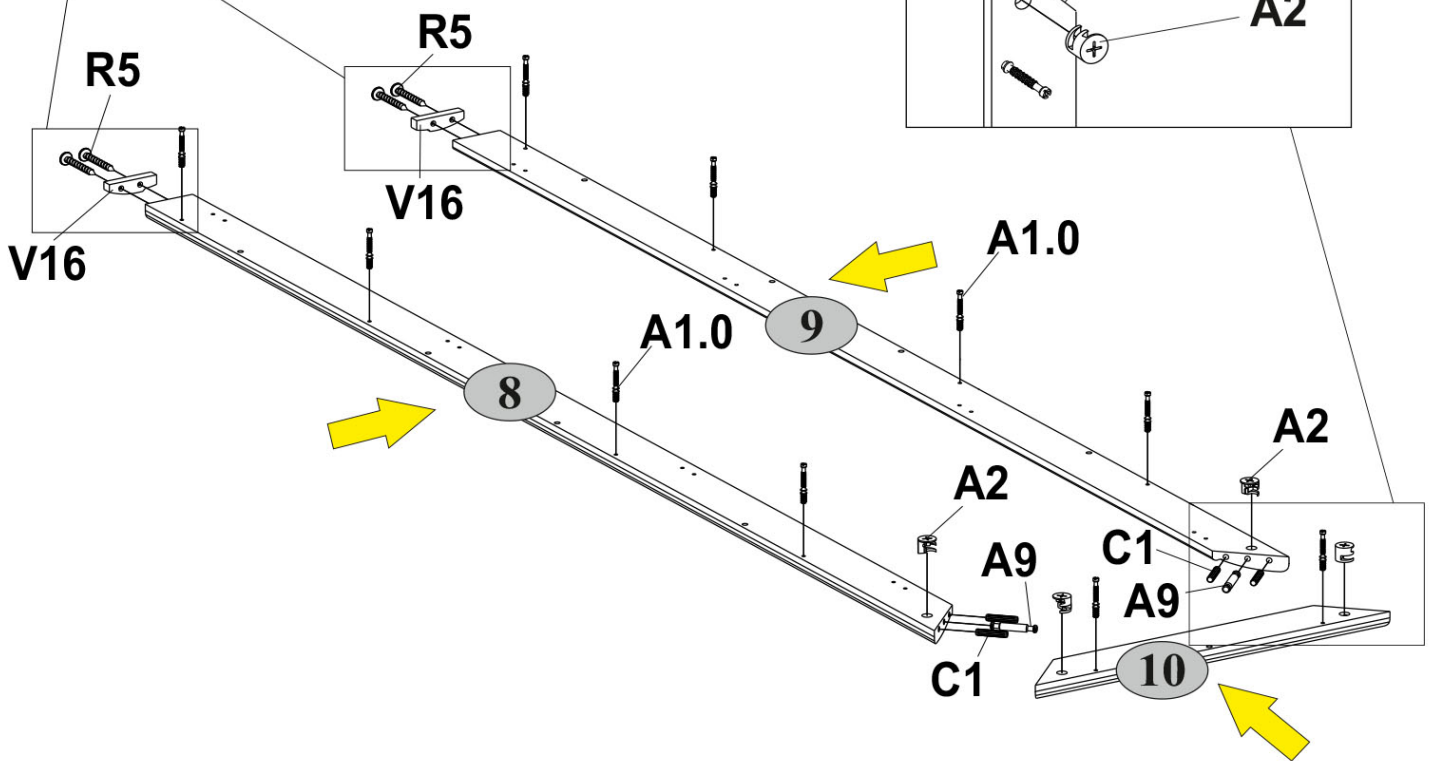
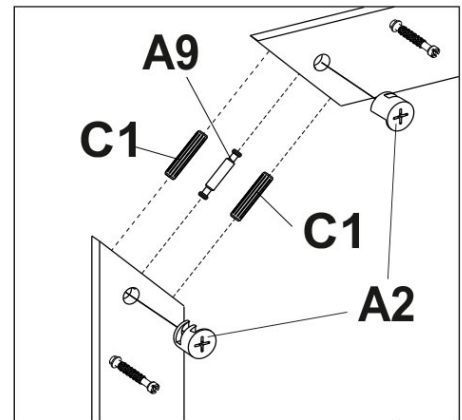
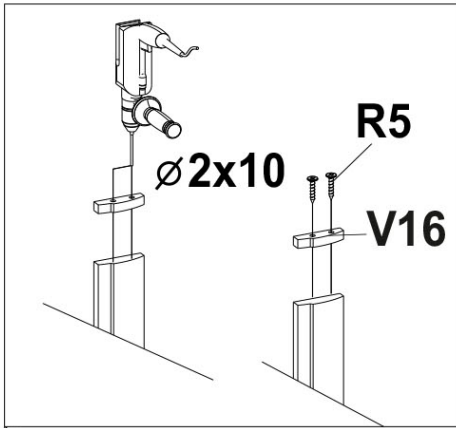



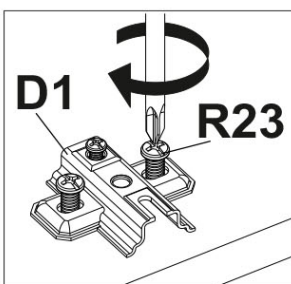
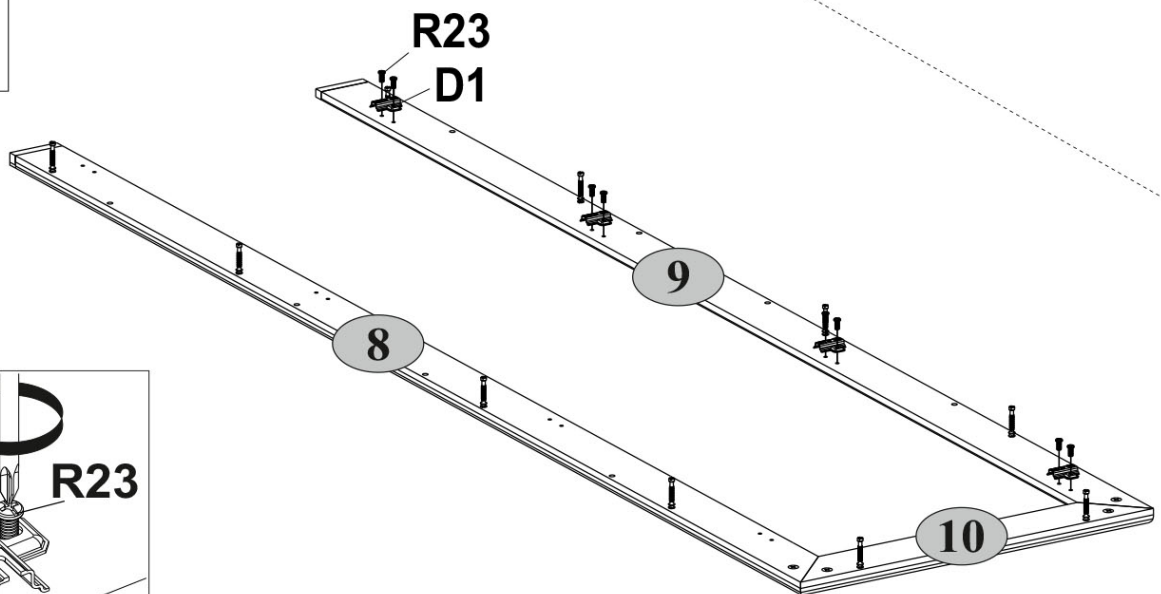
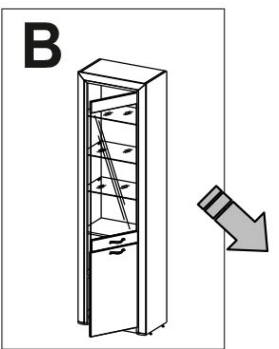
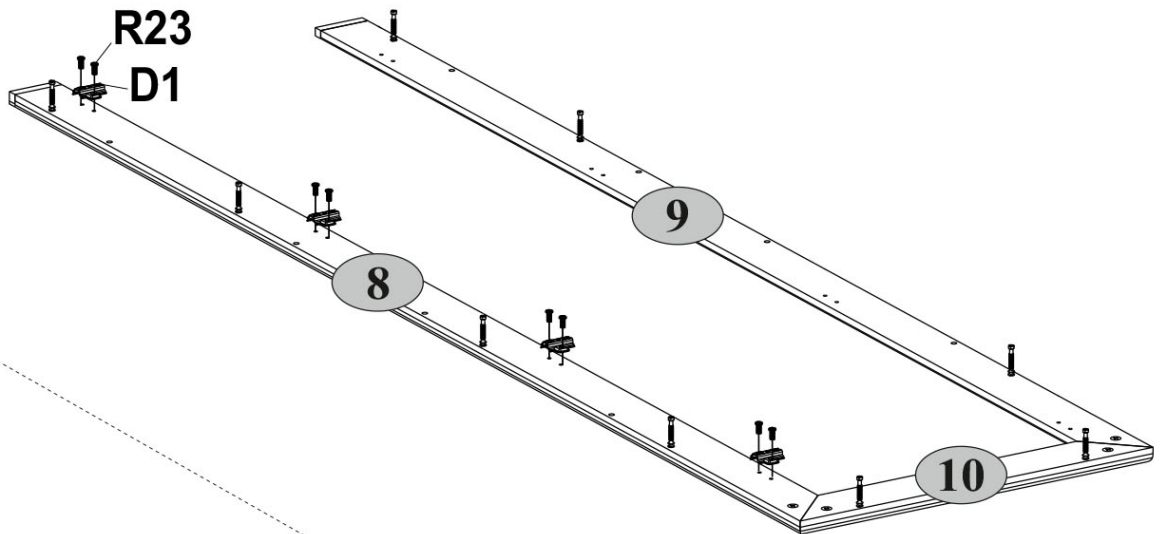
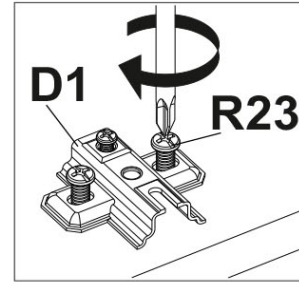
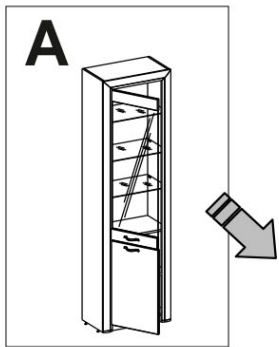
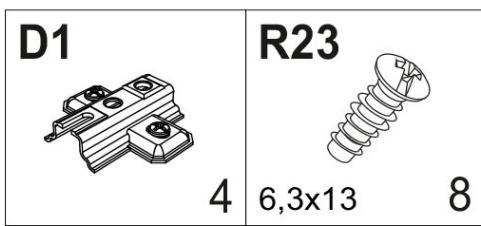

**7**



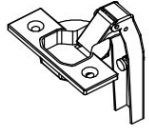

**8**

<b>E2</b>  4	<b>H63</b>  2	<b>M4</b>  M4x22 4	<b>R102</b>  3,5x16 8
---	--	---	--

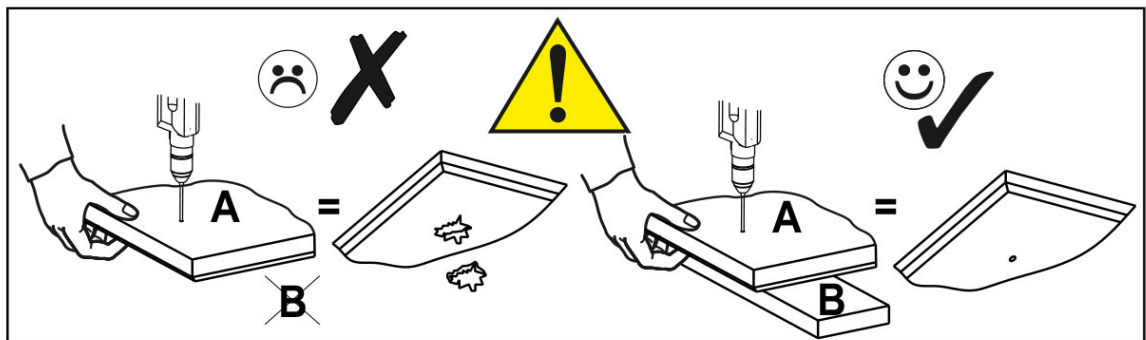
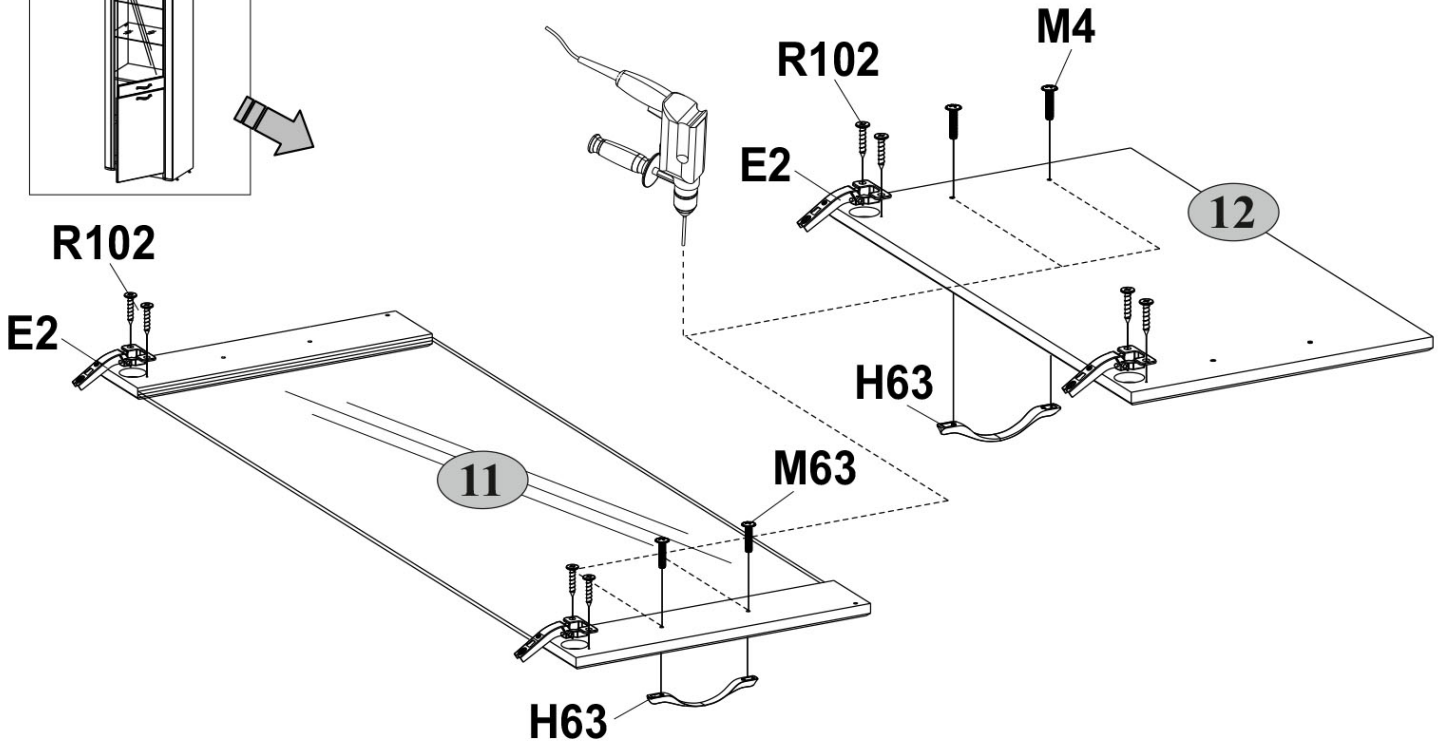
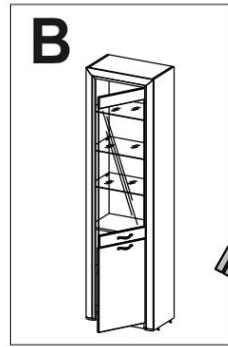
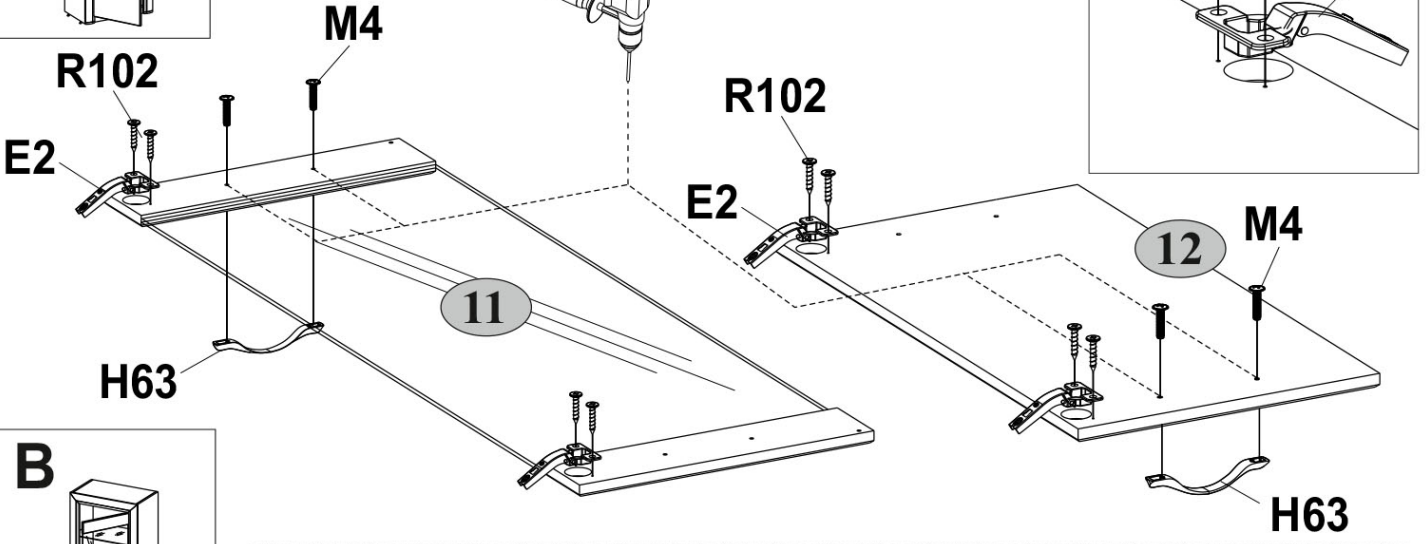
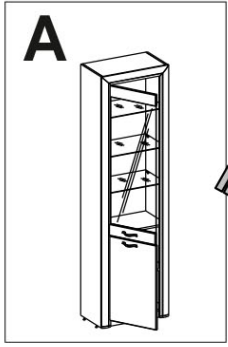

**9**

**B5**  
  
 10x50      1

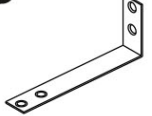
**U**  
  
 130x35x15      1

**Q**  
  
 1,5x7      2

**R102**  
  
 3,5x16      2

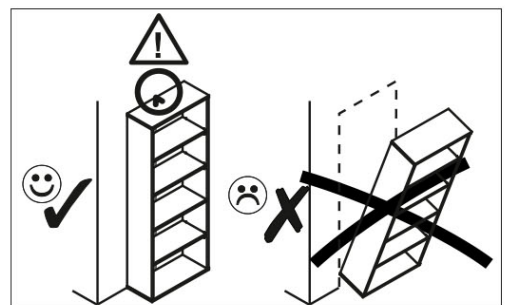
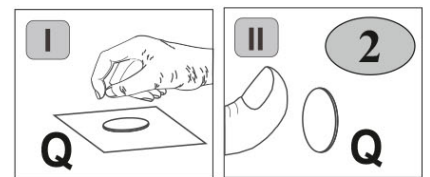
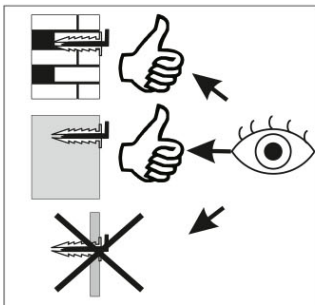
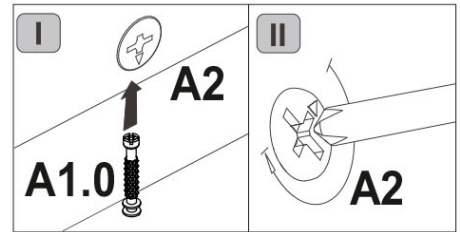
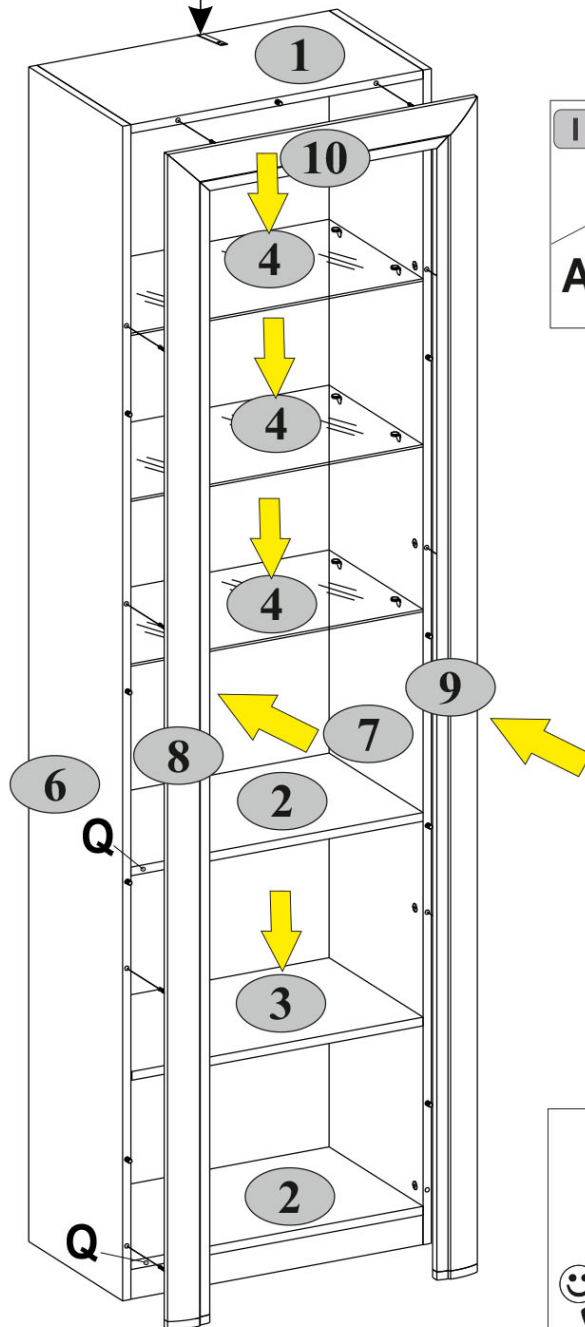
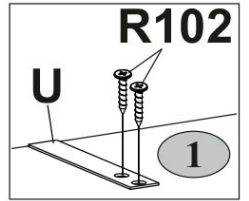
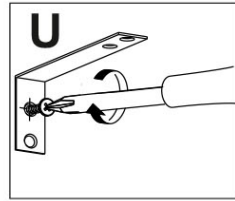
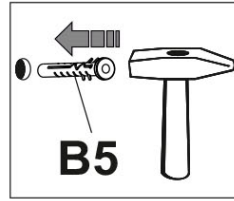
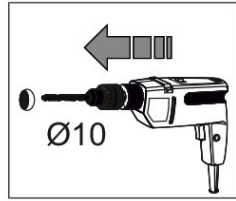
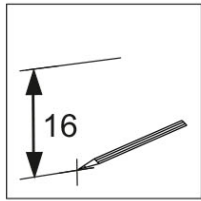
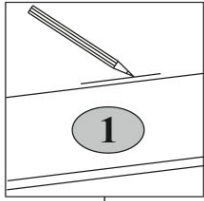

**9**

**B5**  
  
 10x50      1

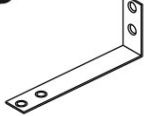
**U**  
  
 130x35x15      1

**Q**  
  
 1,5x7      2

**R102**  
  
 3,5x16      2

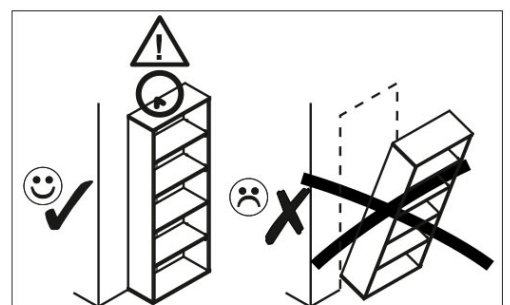
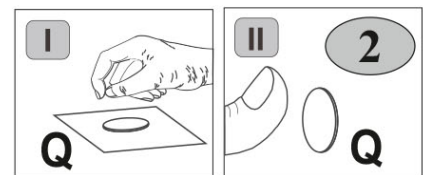
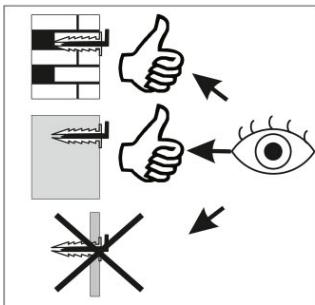
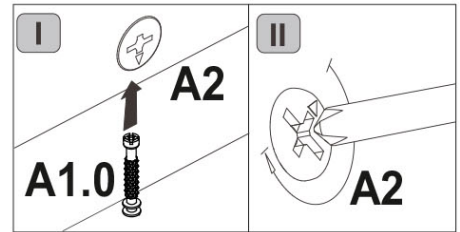
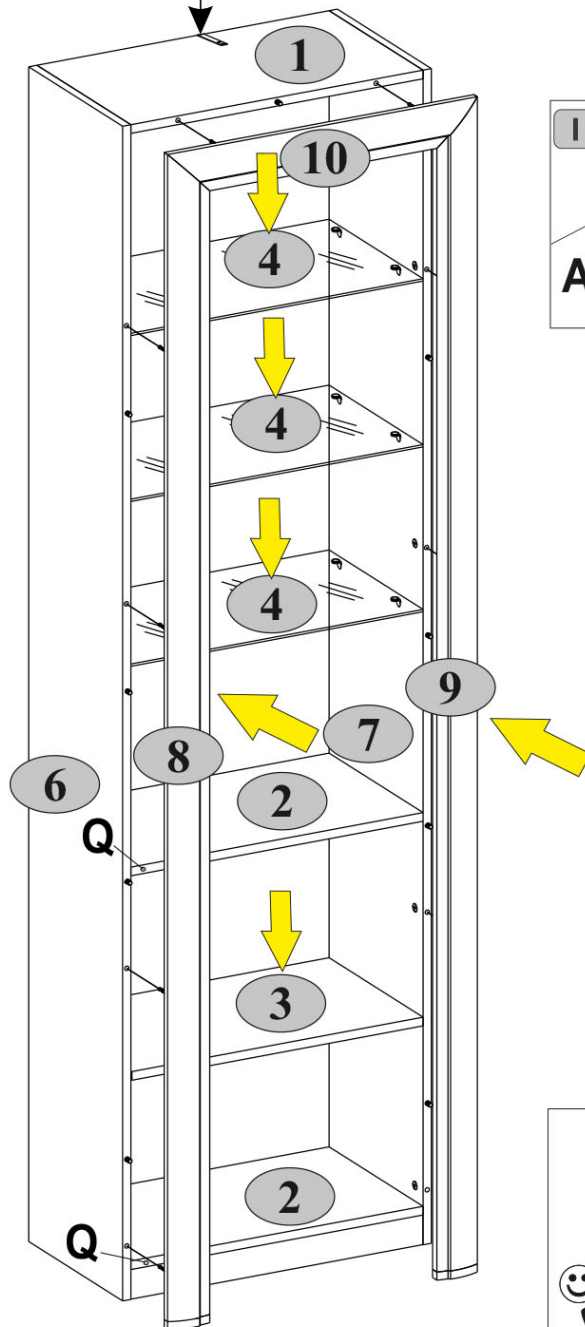
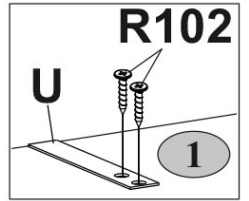
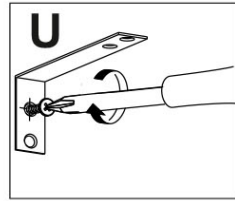
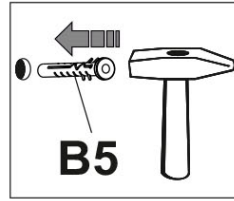
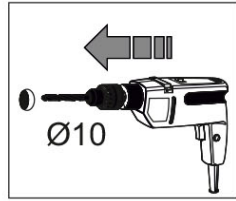
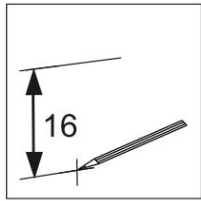
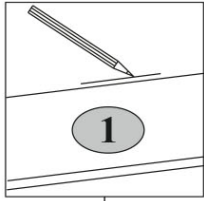

**10**

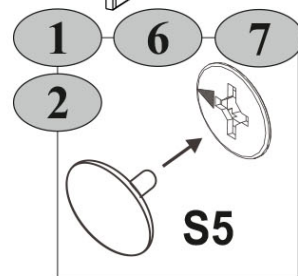
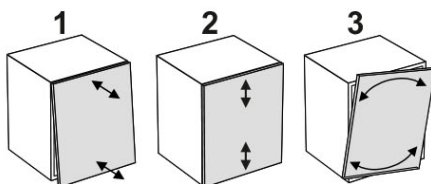
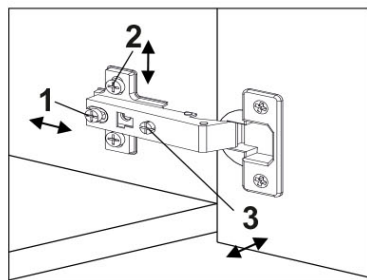
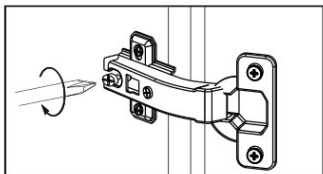
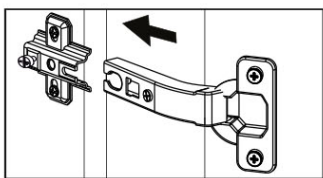
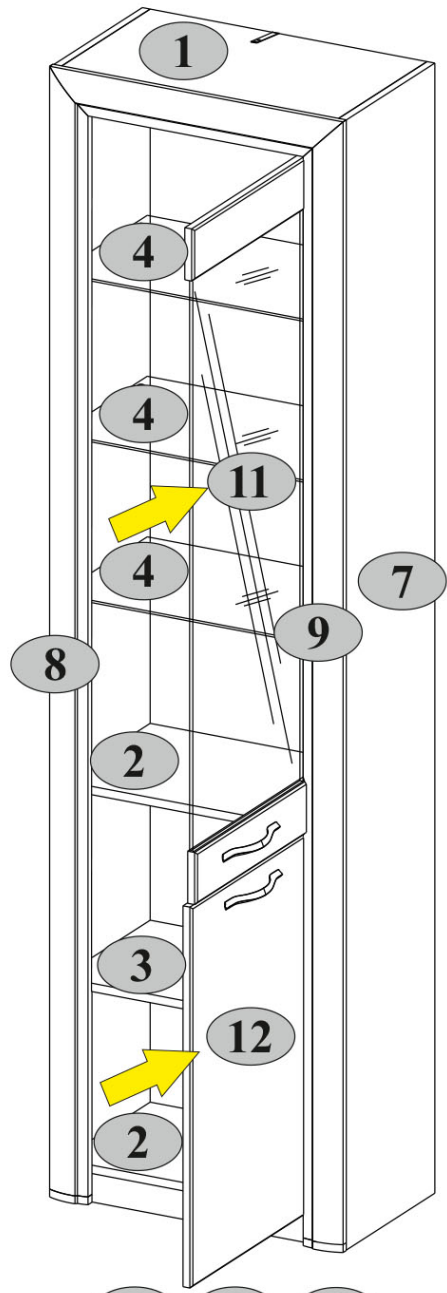
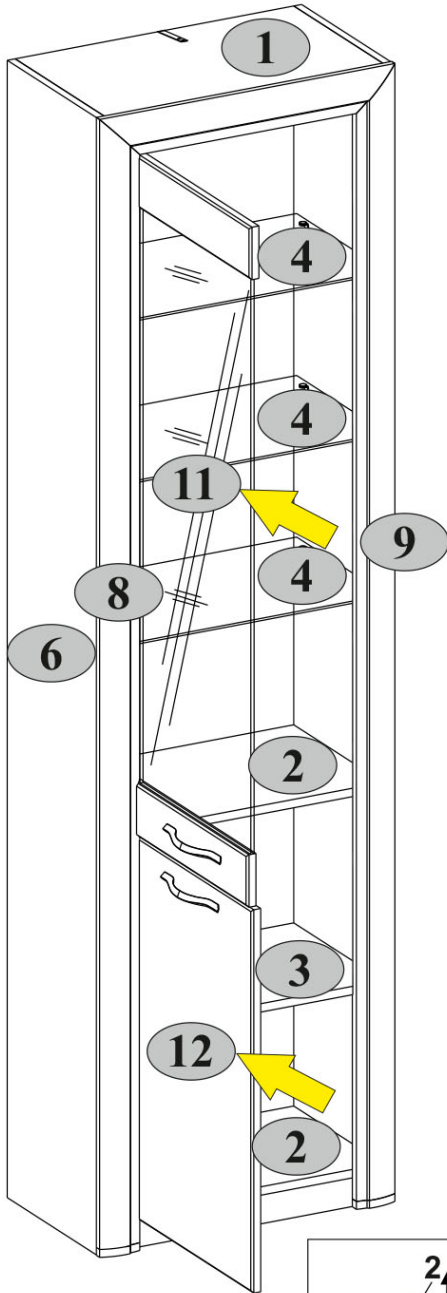
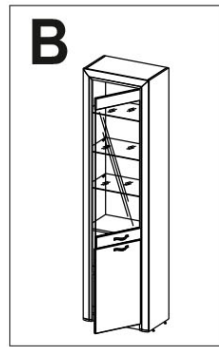
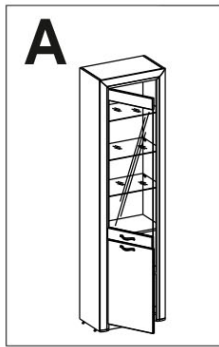
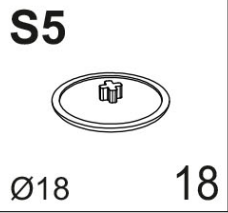

**max. 5 kg**